

Installation & Operators Manual

HURRiCHiLL blast chillers & shock freezers

MODELS COVERED:

AP3BCF30-1-P

AP5BCF45-2-P



*Please read this manual
before installing or
operation of this equipment.*



Versatile, Dependable Walk-Ins & Blast Chillers

5800 SE 78th St. Ocala, FL 34472 • 352.245.7055 • service@americanpanel.com



Simple Controller HURRICHILL Installation & Operations Manual

Warranty	3-4
Basic Safety Information.....	5-6
Equipment Tag.....	6
Pre-installation Checks.....	6
Installation	7
Installation Checklist.....	7-9
Specifications & Performance	9
General Operating Instructions.....	10
Modes Explained	10-11
Display	11
Starting a Cycle	12
Alarm Codes.....	12
Maintenance Instructions.....	13-14
Evaporator Coil Cleaning.....	15

Contacts and Information

Customer service - +1(800) 327-3015 or +1(352) 245-7055

Service department. - service@americanpanel.com

Parts department. - parts@americanpanel.com

Website - www.americanpanel.com

For all blast chiller information requests, please have the Model and Serial Number available as stated on the equipment tag (pg 5) on the exterior of the cabinet.



American Panel HURRiCHiLL Blast Chiller/Shock Freezer Warranty

American Panel Corporation products are warranted to the original user installed within the United States, Canada and Puerto Rico to be free from defects in material or workmanship under normal and proper use, as outlined in the HURRiCHiLL owner's manual and maintenance service specifications provided by American Panel.

The warranty period begins on the date of installation or 30 days from the date of product shipment from American Panel Corporation, whichever comes first. For this warranty to be in effect, the installation checklist/registration must be accurately completed and emailed to service@americanpanel.com within 72 hours from the installation or start-up date.

NOTE: This Warranty does not apply to altered or misused parts.

Self-Contained Units		
WARRANTY COVERS	PARTS	LABOR
Cabinet Assembly	3 Year from date of shipment	3 Year from date of shipment
Refrigeration Components	3 Year from date of shipment	3 Year from date of shipment
Refrigeration Compressor	5 Years from date of shipment	3 Year from date of shipment
Food Temperature Probes & Lights	None	None
Remote Refrigeration Units		
Cabinet Assembly	3 Year from date of shipment	3 Year from date of shipment
Refrigeration Components	3 Year from date of shipment	None
Refrigeration Compressor	5 Years from date of shipment	None
Food Temperature Probes & Lights	None	None

Note: Refrigeration compressor warranty is valid for one time replacement.

This warranty is not assignable and applies only valid to the original purchaser/user to whom delivered. Any such assignment or transfer shall void the warranties herein made and shall void all warranties, express or implied, including any warranty of merchantability or fitness for a particular purpose. There aren't any other warranties expressed, implied or statutory, except the warranties as described above.

American Panel Corporation agrees to repair or replace at its option, FOB Factory, any part which proves to be defective due to defects in material or workmanship during the warranty period, providing the equipment has been properly installed, maintained and operated in accordance with the HurriChill™ User's Manual. Refer to the above chart for details and exceptions for various equipment items. Labor covered by this warranty must be authorized by American Panel Corporation and performed by a factory authorized service agency or factory preferred service company. Contact American Panel Corporation for a list of agents in your area.

This warranty does not apply to remote or pre-assembled remote refrigeration systems requiring electrical inter-wiring or refrigerant piping provided by others. American Panel Corporation reserves the right to withdraw this warranty if it is determined that equipment is not being operated or maintained properly per the HURRiCHiLL operations manual .

WHAT IS NOT COVERED BY THIS WARRANTY

This warranty does not apply to:

- Any aesthetic components
- Door Gaskets
- Bulbs, Condenser Filters, Food Probes, Damaged or Misused Probes
- Unit(s) moved from original installation site or location or during any shipping.
- Software update/parameter modification

American Panel will not assume:

- Responsibility for economic loss; profit loss or special indirect or consequential damages, including but not limited to, losses or damages arising from food or product spoilage claims, delayed installations or shipping, parts shortages, labor shortages or strikes.
- Liability for parts or labor coverage for component failure or other damages resulting from improper usage or installation or failure to clean and/or maintain product per the HURRICHILL operations manual.
- Responsibility for the repair or replacement of any parts that American Panel determines have been subjected after the date of manufacture to alteration, neglect, abuse, misuse, accident, damage during transit or installation.
- Responsibility for the repair or replacement of failed or damaged components resulting from improper voltage feeds, electrical power failure, electrical storm or grid power surges, the use of extension cords, low voltage, or voltage drops or spikes to the unit.
- Responsibility for any damages caused during or at any storage facility including but not limited to, dealer and on/off site storage.

TRANSPORTATION DAMAGE AND CLAIMS

All American Panel equipment is sold FOB shipping point, and when accepted by the carrier, such shipments become the property of the consignee. Should damage occur in shipment, it is a matter between the carrier and consignee. In such cases, the carrier is assumed to be responsible for the safe delivery of merchandise, unless negligence can be established on the part of the shipper.

- Make an immediate inspection while equipment is still in the truck or immediately after it is moved to the receiving area.
- Do not sign a delivery receipt or freight bill until you have made a proper count and inspection of all merchandise received.
- Note all damage to packages directly on the carrier's delivery receipt.
- Make certain the driver signs this receipt. If he refuses to sign, make a notation of this refusal on the receipt.
- If the driver refuses to allow inspection, write the following on the delivery receipt, "Driver refuses to allow inspection of containers for visible damage".
- Save any packages and packing material for further inspection by the carrier.
- Promptly file a written claim with the carrier and attach copies of all supporting paperwork.

American Panel requires that the consignee unpack and fully inspect their unit(s) for any concealed freight damage. Any claims for concealed freight damaged must be reported to American Panel within 72 hours of receipt of shipment via email to traffic@americanpanel.com.

During the warranty period, all requests for service MUST be made before any work is begun. Such requests must be directed to American Panel Corporation Service Department, which will issue written authorization when applicable. Without this authorization, the Warranty may be voided. The service department can be contacted by mail at **American Panel Corp., 5800 S.E. 78th Street, Ocala, Florida 34472-3412**; by telephone at **1-800-327-3015**; by fax at **(352) 245-0726**; or via email at service@americanpanel.com.

Service department hours - **Monday - Friday 8am-5pm EST.**

American Panel will continue its policy of assisting our customers in collecting claims which have been properly filed and actively pursued. American Panel will not assume the responsibility of any claims nor accept deductions in payment for such claims.

**** Proper installation is the responsibility of the dealer, the owner-user, or the installing contractor. It is not covered by this warranty.**



Basic Safety Information



WARNING - This equipment contains flammable refrigerant. Take extra care when moving this equipment not to damage any refrigeration part. Avoid excessive vibration and jarring to minimize the risk of refrigerant leak.



DANGER - This equipment contains flammable refrigerant. It must be repaired only by trained service personnel.



WARNING – This equipment has been manufactured to comply with specific guidelines and standards that pertain to flammable refrigerants. Only OEM parts must be used to repair this equipment.



WARNING - Please read the entire installation procedure before attempting to install the unit. Failure to follow the procedures listed in this manual may result in voiding the warranty.



IMPORTANT - Due to the size and weight of this equipment, a minimum of two people is required to install this equipment safely. All OSHA regulations must be followed while on the job site.



IMPORTANT – Install this equipment in a well-ventilated area!

Do not install this equipment near any ignition source such as open flame!

Do not touch or operate the machine with damp or wet feet and hands.

Do not insert screwdrivers, kitchen tools or other items between the protections and the moving parts.

Before carrying out cleaning operations or routine maintenance, disconnect the machine from the power supply mains, switching the master switch off and removing the plug.

If the power supply cable is damaged, it must be replaced by a service provider or similarly qualified staff, in order to avoid risks.

This unit must be equipped with a disconnection device incorporated in the fixed connection in compliance with local regulations.

When loading the machine, the use of kitchen gloves is recommended in order to prevent burns on contact with the hot trays and trolleys.

Use gloves suitable for trays and cold trolleys. During cleaning operations, of the condenser in particular, always wear protective gloves, safety glasses and mask for the respiratory protection.

The core probe must only be used for the purpose for which it has been designed: detect the temperature at the center of the food stuffs to be blast chilled and/or frozen.

It is prohibited to remove the protections and safety devices in order to perform routine maintenance.

Do not block the ventilation openings of the unit and of the structure in which it is positioned.



WARNING - Please read the entire installation procedure before attempting to install the unit. Failure to follow the procedures listed in this manual may result in voiding the warranty.



IMPORTANT - Due to the size and weight of this equipment, a minimum of two people are required to install this equipment safely. All OSHA regulations must be followed while on the job site.

Simple Controller HURRICHILL Installation & Operations Manual

- This manual is an integral part of the product, it supplies all of the indications necessary for correct installation, correct use and maintenance of the machine.
- It is mandatory for the user to read this manual carefully and always make reference to it. It must be kept in a place that is known and accessible to the authorized operators (installer, user, maintenance technician)
- The blast chiller is intended for professional use and therefore only qualified staff can use it
- The blast chiller is destined only for the use for which it has been designed.
- The manufacturer declines all responsibility for any

damage caused by incorrect or unreasonable use, as for example:



- improper use by untrained staff.
- modification or interventions that are not specific for the model.
- use of non-original spare parts or that are not specific for the model.
- failure to comply, even partial, with the instructions in this manual.
- The manufacturer disclaims all responsibility for problems related to an incorrect installation of the blast chiller.
- The blast chiller must be installed by an authorized service/install provider.

Equipment Tag

The equipment tag is located on the exterior of the unit and displays the following information that is unique to the unit:

- Model Number
- Serial Number
- Refrigerant Charge
- Refrigerant Pressure (Low & High)
- Electrical Volts, Phase, Hertz and Amps
- Minimum Circuit Amps
- Maximum Fuse Size (Amps)

Please have this information on hand when contacting service or parts.

		5800 S.E. 78th STREET, OCALA, FL. 3447 FOR SERVICE CALL: 800-327-3015	
MODEL NO.		SERIAL NO.	
XXXXXXXX		XXXXXXXX	
REFRIGERANT:	<input type="text"/>	DESIGN PRESSURE (LOW):	<input type="text"/>
CHARGE IN OZ:	<input type="text"/>	DESIGN PRESSURE (HIGH):	<input type="text"/>
VOLTS:	<input type="text"/>	PH:	<input type="text"/>
		HZ:	<input type="text"/>
MINIMUM CIRCUIT AMPS:	<input type="text"/>	MAX FUSE SIZE:	<input type="text"/> A
		COMMERCIAL REFRIGERATOR AND/OR FREEZER 28E3	



Pre-installation Checks

- **Check components against the packing list. The packing list is located inside the accessory box.**
- **Check the integrity of the components once unpacked.**
- **Check for proper location**
 - Ambient temperature no greater than 90°F
 - Do not install near heat source
 - Do not install near vapor source
 - Do not install near grease source
 - Do not install in direct sun light
 - Do not install in closed areas with insufficient air change
- **Check for proper clearances**
 - See page 7 for clearances.
- **Check for unobstructed air flow at the condensing unit**

Installation

American Panel Corporation equipment has been shipped in a package designed to sufficiently protect from damage under normal shipping circumstances. Upon receiving the shipment, carefully inspect the package for visible damage and check the number of packages against the Bill of Lading. Notify the carrier immediately of any shortage or damage to your shipment. Claims must be filed promptly with the carrier.

After receipt of shipment, carefully and safely remove the unit from the package. Check the contents of the package against the packing list. Under no circumstances may a damaged piece of equipment be returned to American Panel Corporation without first obtaining written permission.

To assure proper installation carefully read and comply with the following instructions.



WARNING - Please read the entire installation procedure before attempting to install the unit. Failure to follow the procedures listed in this manual may result in voiding the warranty.



IMPORTANT - Due to the size and weight of this equipment, a minimum of two people are required to install this equipment safely. All OSHA regulations must be followed while on the job site.

Installation Checklist

Check the integrity of the unit once it is unpacked.

Check for proper location.

- Install this equipment in a well-ventilated area.
- Do not install this equipment near any ignition source such as open flame
- Ambient temperature no greater than 90°F (to ensure rated performance)
- Do not install near heat source
- Do not install near vapor source
- Do not install in direct sun light
- Do not install in closed areas with insufficient air change

Check for proper clearances

- 3" clearance on both sides of the unit
- 5" clearance on the back of the unit
- Provide enough space in front to allow door opening
- Check for unobstructed air flow at the condensing unit
- Always keep the unit in the upright position

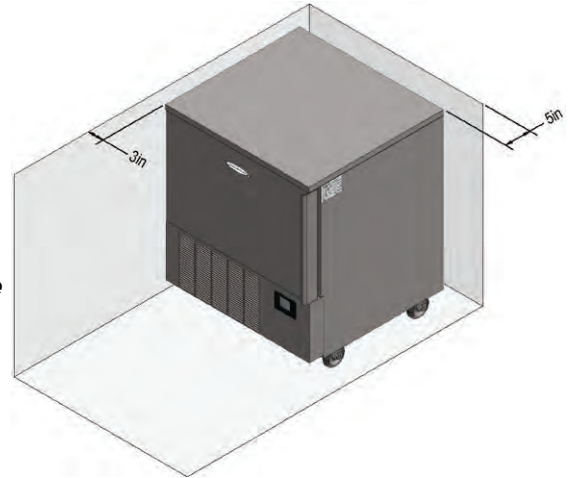

Failure to comply with the above note may cause severe damage to the unit and will void the warranty.

Verify the electrical service to be in accordance with the manufacturer label located on the right side of the unit.

Connect the unit to the mains.

- Plug the unit into the wall receptacle

Condensate Drainage

- Install drain pan or drain line. Install the drain pan by sliding the pan on the guides located on the bottom of the unit. When installing the drain line the drainage connection must be carried out in conformity with the local regulation. As a standard configuration, all reach-in Hurrichill units are provided with 3/4" ID flexible tubing drain line.

Install wire shelves (if so equipped).

Operate the unit in Freeze time driven mode for approximately 20 minutes to verify temperature pull down, see chapter Unit Operation.



Note: American Panel Corporation blast chillers are equipped with a short cycle protection. If the unit is stopped or the door is opened and closed during a chilling cycle more than once, the compressor will not start for a period of 3 to 5 minutes.

Engage, operate and verify effectiveness of manually engaged defrost cycle, see chapter Unit Operation – Defrost Cycle.

Inform the factory if any functional and performance issues were found following the completion of the above tests.

Verify that the operator has all necessary operation manuals, menus and instructions. Contact factory with any questions, Monday-Friday 8:00 a.m. to 5:00 p.m. ET at 800-327-3015 or consult the website at www.americanpanel.com

Specifications and Performance

The performance listed below was achieved under the conditions listed below:

- Ambient temperature of 77°F.
- Blast chiller prechilled to 0°F.
- Product was loaded in steam table pans, 12" x 20" x 2 ½".
- Product thickness of 2" maximum.
- Pans were left uncovered.

Blast chilling - Capable of lowering the core temperature of product from 160°F to 38°F within 105 minutes.

Shock freeze - Capable of lowering the core temperature of product from 160°F to 0°F within 240 minutes.

Model	Type	Pan Capacity Sheet/Steam	Chilling Capacity (105 min)	Freezing Capacity (240 min)
AP3BCF30-1-P	Blast Chiller/Shock Freezer	0/3	30	18
AP5BCF45-2-P	Blast Chiller/Shock Freezer	0/5	50	30



Note: Each unit was designed for a specific product capacity as shown above. Overloading the unit could significantly reduce its service life.

General Operating Instructions

Panning and Loading

Follow the methods below for faster cooling, freezing and thawing:

- Place the food in shallow pans.
- Do not use food pans deeper than 2 ½" and do not fill the pan with more than 2" of product.
- Separate the food in smaller or thinner portions.
- Do not cover the containers unless danger of overhead contamination.
- Loosely cover the containers if necessary. Allow the cover material (aluminum foil) to touch the surface of the food.
- Arrange the pans for optimum air circulation within the cabinet.
- Know the capacity of the unit. Do not overload the unit.

Probing (for chilling and freezing cycles)

Follow the methods below to ensure correct probing of the product:

- Insert the food probe into the thickest part of the product.
- The tip of the food probe will have to be located at the core of the food.
- Always place the available food probe in the hardest to cool product.
- It is a good practice to restart the cycle every time food is added.
- Clean and sanitize the food probe after each use.

Modes Explained

There are two cycles available, **Chill** and **Freeze** with the option of adding a **Hard** phase to the **Chill** cycle and a **Soft** phase to the **Freeze** cycle. Each cycle can run in automatic (food temperature dependent) or manual (time dependent) mode.

Soft Chill: Soft Chill cycle is design to safely chill all food products without any freezing.

During the active cycle, the air temperature will cycle between 28°F and 33°F. In the automatic mode the cycle will continue until the food probe senses the food target temperature set at the start of the cycle, default food target temperature is 38°F. In the manual mode the cycle will continue until the timer set at the beginning of the cycle expires, the default timer is set for 500 minutes.

At the end of the cycle the unit will maintain an air temperature between 35°F and 40°F until the user removes the food from the cabinet and stops the cycle.

Hard Chill: Hard Chill works best for batch chilling - one type of product in the entire cabinet, with similar thickness and initial temperature.

Add the Hard phase to Chill cycle to achieve a shorter the chilling time. Note that in order to avoid surface freezing of the product the unit must be loaded with the same product at the same time.

During the Hard phase of the cycle, the air temperature will cycle between 0°F and 5°F. In automatic mode the Hard phase will end when the food probe senses the food temperature of 50°F. In the manual mode the Hard phase will end after 60 minutes. At the end of the Hard phase of the cycle the controller will revert to Soft Chill cycle until the food target temperature is achieved, see Soft Chill cycle above.

Hard Freeze: Used to quickly freeze all food products.

During the active cycle the air temperature will cycle between -25°F and -20°F. In the automatic mode the cycle will continue until the food probe senses the food target temperature set at the start of the cycle, default food target temperature is 0°F. In the manual mode the cycle will continue until the timer set at the beginning of the cycle expires, the default timer is set for 500 minutes.

At the end of the cycle the unit will maintain an air temperature between -4°F and 1°F until the user removes the food from the cabinet and stops the cycle.

Soft Freeze: Add a Soft phase to your freeze cycle to cool the core of the food product before beginning the freezing process. The Soft phase will lengthen the freezing time but it is useful in certain applications such as pastry and confectionary. During the Soft phase of the Soft Freeze cycle the air temperature will cycle between 28°F and 33°F. In the automatic mode the Soft phase part of the cycle will continue until the food probe senses a food temperature below 38°F. In the manual mode the Soft phase will end after 90 minutes.

At the end of the cycle the unit will revert to Hard Freeze, see Hard Freeze cycle above.

Fish Sanitation (AP5BCF45-2-P only): Used to control parasites in fish and it follows the CDC guidelines. The air temperature will drop to a range of -36°F to -31°F. After the fish core temperature reaches -4°F the air temperature will cycle between -10°F and -5°F for a period of 24 hours. After the 24 hours period expire, the controller will hold the same temperature range until the user removes the fish from the cabinet and stops the cycle.

Hardening: Use to harden the surface of gelato. This is a continuous Hard Freeze cycle. Once the air temperature cycle reaches the range of -25°F and -20°F a timer preset for 10 minutes will start countdown every time the door is opened.







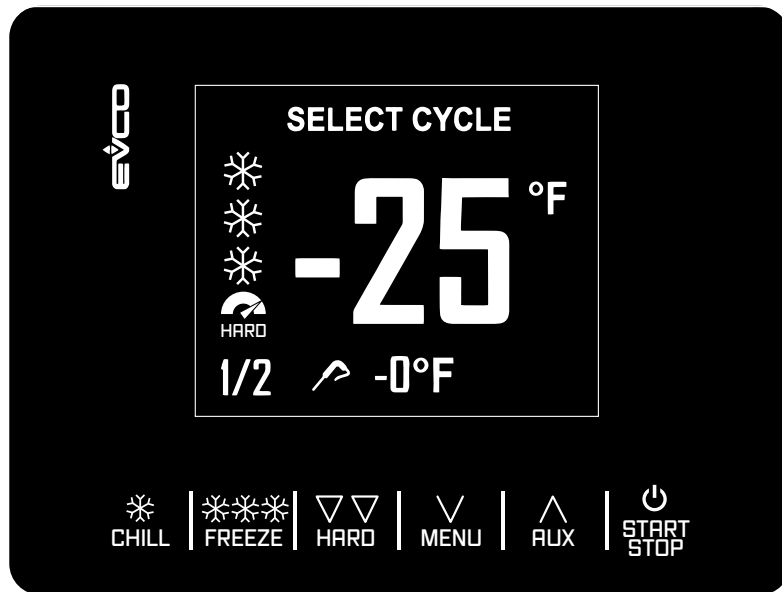

NOTE: *The blast chiller must be manually defrosted every 8 hours of continuous operation or more often if needed.*











Display



Controller Keys

Key	Function
	<ul style="list-style-type: none"> - Select blast chill cycle. - Switch between automatic and manual modes. - While in a menu, acts as the ESC key. Press this button to return to the previous screen or menu option.
	<ul style="list-style-type: none"> - Select the shock freeze cycle. - Switch between automatic and manual modes.
	<ul style="list-style-type: none"> - After selecting the CHILL or FREEZE cycle, press HARD button to switch between Soft and Hard modes.
	<ul style="list-style-type: none"> - From Home screen press MENU button to access the settings menu. - Within a menu list, press \downarrow to scroll down. - While modifying a parameter, press \downarrow to decrease the value of the parameter being modified.
	<ul style="list-style-type: none"> - While in Home screen, press AUX to gain access to special cycles menu. - Within a menu list, press \uparrow to move up the list. - While modifying a parameter, press \uparrow to increase the value of the parameter being modified.
	<ul style="list-style-type: none"> - Short press to start the selected cycle. - Long press (for 2 seconds) to turn off the active cycle. - Within a menu list it selects the highlighted menu option. - While modifying a parameter, press START/STOP button to confirm the change to the parameter.

Controller Icons

Icon	Description
	Indicates cabinet temperature during the standby mode.
	Indicates food temperature.
	Soft Chill cycle
	Hard Chill cycle
	Hard Freeze cycle
	Soft Freeze cycle
	Manual mode, time dependent.
	Cycle in progress
	Compressor output on
	Cabinet door is open. Close the door or press any key to cancel door open alarm.
	Phase in progress. Relevant to hard chill and soft freeze cycles.

Operation

Precooling

- With the controller in standby mode press AUX button.
- Use the ^ and v buttons to scroll and highlight PRECOOLING

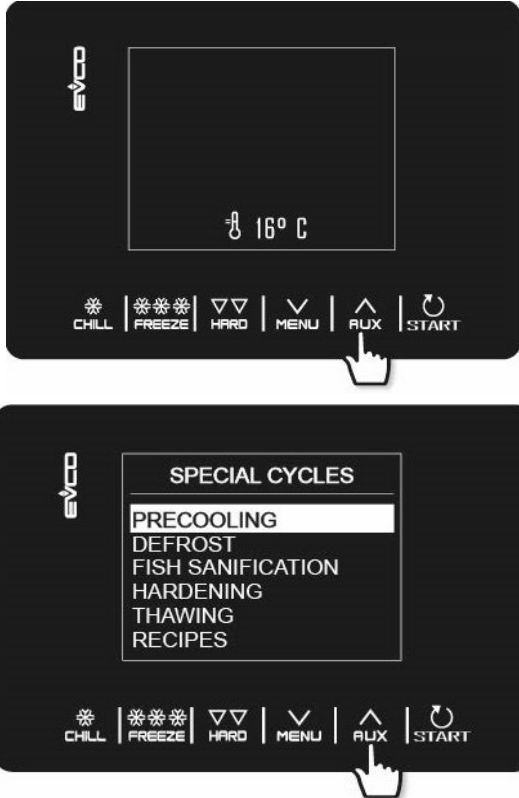



- Press START/STOP button to select it.
- Use the ^ and v buttons to adjust the precool target temperature of the cabinet.
- Press START/STOP button to start the precool cycle.
- When the air temperature reaches the target temperature, the controller will beep 5 times and it will maintain the air temperature within 5 degrees.

Automatic Soft Chill

- With the controller in standby mode press CHILL button.
- Use ^ and v buttons to adjust the target temperature of the food – optional.



NOTE: If the controller is set to Automatic mode  **but the user does not insert the probe, the controller will revert to Manual mode** .

- Press START/STOP button to turn on the cycle.





NOTE: To turn off a cycle long press START/STOP button.

Automatic Hard Chill

- With the controller in standby mode press CHILL button.
- Press HARD button to select the Hard Chill cycle.
The controller will show the hard icon .
- Use ^ and v buttons to adjust the target temperature of the food – optional.



NOTE: If the controller is set to Automatic mode  **but the user does not insert the probe, the controller will revert to Manual mode** .

- Press START/STOP button to turn on the cycle.





NOTE: To turn off a cycle long press START/STOP button.

Automatic Hard Freeze

- With the controller in standby mode press FREEZE button.
- Use ^ and v buttons to adjust the target temperature of the food – optional.



NOTE: If the controller is set to Automatic mode  **but the user does not insert the probe, the controller will revert to Manual mode** .

- Press START/STOP button to turn on the cycle.





NOTE: To turn off a cycle long press START/STOP button.

Automatic Soft Freeze

- With the controller in standby mode press FREEZE button.
- Press HARD button switch to Soft Freeze cycle.
- Use ^ and v buttons to adjust the target temperature of the food – optional.

Operation - *continued*



NOTE: If the controller is set to Automatic mode  but the user does not insert the probe, the controller will revert to Manual mode .

- Press START/STOP button to turn on the cycle.



NOTE: To turn off a cycle long press START/STOP button.



Manual Soft Chill

- With the controller in standby mode press CHILL button.
- Press CHILL button again to switch to Manual mode. The controller will display the preset chilling time and the timer icon .
- Use ^ and v buttons to adjust the chilling time – optional.
- Press START/STOP button to turn on the cycle.



NOTE: To turn off a cycle long press START/STOP button.

Manual Hard Chill

- With the controller in standby mode press CHILL button.
- Press CHILL button again to switch to Manual mode. The controller will display the preset chilling time and the timer icon .
- Press HARD button to select the Hard Chill cycle. The controller will show the hard icon .
- Use ^ and v buttons to adjust the chilling time – optional.
- Press START/STOP button to turn on the cycle.



NOTE: To turn off a cycle long press START/STOP button.

Manual Hard Freeze

- With the controller in standby mode press FREEZE button.
- Press FREEZE button again to switch to Manual mode. The controller will display the preset cycle time and the timer icon .

- Use ^ and v buttons to adjust the cycle time – optional.
- Press START/STOP button to turn on the cycle.



NOTE: To turn off a cycle long press START/STOP button.

Manual Soft Freeze

- With the controller in standby mode press FREEZE button.
- Press FREEZE button again to switch to Manual mode. The controller will display the preset cycle time and the timer icon .
- Press HARD button switch to Soft Freeze cycle.
- Use ^ and v buttons to adjust the cycle time – optional.
- Press START/STOP button to turn on the cycle.



NOTE: To turn off a cycle long press START/STOP button.

Defrost

- With the controller in standby mode press AUX button.
- Use the ^ and v buttons to scroll and highlight DEFROST.
- Press START/STOP button to select it.
- Open the cabinet door and press START/STOP button to start the defrost cycle.

Fish Sanitation (AP5BCF45-2-P only)

- With the controller in standby mode press AUX button.
- Use the ^ and v buttons to scroll and highlight FISH SANITATION.
- Press START/STOP button to select it.
- Press START/STOP button to turn on the cycle.

Hardening

- With the controller in standby mode press AUX button.
- Use the ^ and v buttons to scroll and highlight HARDENING.
- Press START/STOP button to select it.
- Use ^ and v buttons to adjust the timer – optional.
- Press START/STOP button to turn on the cycle.

Maintenance Instructions

Daily Maintenance

- Defrost the unit daily or as needed.
- Wipe clean the interior and the exterior of the unit using a solution of mild soap and water.
- Wipe clean the door gasket



IMPORTANT!

Do not use any corrosive chemicals to clean the unit!

Do not use any abrasive materials to clean the unit!

Do not spray water on the unit!

Quarterly Maintenance

The quarterly maintenance should be done by a service technician or by trained maintenance personnel.

- Inspect door hinge for proper operation.
- Inspect door gasket for proper seal.
- Inspect the drain line for proper flow.
- Use vacuum and brush to clean the condenser coil.
- Clean the evaporator coil.
- Inspect the site glass to ensure it's clean and dry
- Use an 80/20 ice/water bath to check the accuracy of the probes.



IMPORTANT!

Do not use water jet to clean the condenser coil!

Do not use any sharp or abrasive materials to clean the coils!

Annual Maintenance Checklist The quarterly maintenance should be done by a service technician or by trained maintenance personnel.

- Verify unit is properly installed, see installation checklist at the beginning of this manual.
- Check door hinges and gasket for proper operation and seal. Use mild soapy warm water to clean the door gasket.
- Inspect integrity of the unit, exterior and interior
- Verify evaporator fans are firmly mounted, balanced, free-turning and properly aligned.
- Disconnect unit from the main power and clean the evaporator coil, see the evaporator coil cleaning procedure at the end of this checklist.
- Wipe down cabinet interior with soapy water and rinse. Do not use any abrasive or corrosive materials!
- Inspect and clean the condenser coil
 - Disconnect the unit from power and remove the front and back air inlet/outlet panels. With great care given to electrical connections and moving parts, inspect the integrity of the condensing unit.
 - Lightly brush clean/vacuum any lint and/or dust in cavity with special attention given to the condenser. **Do not use any abrasive or corrosive materials.**
 - Re-install the front and back air inlet/outlet panels.
- Connect the unit to power supply.

- Use an 80/20 ice/water bath to check the accuracy of the probe. To do so, close the door of the unit with the probe hanging on the outside of the cabinet and start a manual hard cycle. Use the probe to continually stir the ice-water bath and observe the readings for approximately 3 minutes. The temperature of the ice-water mixture should be 32 to 33°F.
- Verify the accuracy of the air probe against a calibrated thermocouple or against an accurate food probe.



Note: *American Panel Corporation blast chillers are equipped with a short cycle protection. If the unit is stopped during a chilling cycle more than once, the compressor will not start for the following 3 minutes.*

- Operate the unit in the hard chill / manual mode, for approximately 20 minutes, to verify temperature pull down.
- Verify the functionality of the evaporator fans. The direction of the air flow for the evaporator should be from the front of the unit towards the back of the unit.
- Verify the functionality of the condenser fans. Air direction should be from the front of the unit towards the back.
- Engage, operate, and verify effectiveness of manual defrost cycle.
- Turn unit off, wipe down the exterior with mild soap and water.
- Inform the customer and the factory of any functional and performance issues found following the completion of the above checks.
- Complete inspection paperwork and verify consumer has all necessary operation manuals, menus, and instructions. Contact factory with any questions. Monday-Friday 8am to 5pm EST. 1-800-327-3015 or through the website at www.americanpanel.com.



The above maintenance procedure should be done twice a year and is not a substitute for an efficient local maintenance schedule such as daily and quarterly maintenance schedule.

Evaporator Coil Cleaning

The following cleaning procedure is recommended as part of routine maintenance activity for all American Panel Corporation blast chillers.



IMPORTANT: Do not use any sharp or abrasive tools to clean the evaporator coil!

Before cleaning the evaporator coil run the defrost cycle to make sure the coil is completely free of ice.

When cleaning the evaporator coil particular attention must be paid to the kind of cleansing agent used. The following products **MUST NEVER BE USED**:

- Ammonia or detergents which contain ammonia (ammoniac solutions)
- Bleach or products containing bleach (chlorinated liquids)
- Acid detergents such as anti-lime scale, various anti-incrustations, muriatic acid, sulfuric, hydrochloric and acetic acid liquids, etc. (highly acidic liquids)
- Acetone, trichloro-ethylene (organic solvents)
- Caustic soda and other highly alkaline substances (high basicity liquids)

All the above substances can damage the protective coating and/or corrode the metal components and seriously damage the coil.



WARNING: Disconnect and lock the main power switch prior to cleaning the unit.

Monthly

- Open the evaporator door by removing the screws that secure the door to the vertical frame and swing the door open.
- Use a vacuum cleaner or a soft non-metallic bristle to remove the surface loaded fibers and dirt. Apply the tool in the direction of the fins.
- Rinse the coil finned area and the return bends with plenty of clean warm water. To avoid damaging the fins and the coating, it is important that the water temperature is below 130oF and the water pressure is below 100 PSI.
- Close and secure the evaporator door.

Quarterly

- Open the evaporator door by removing the screws that secure the door to the vertical frame and swing the door open.
- Use a vacuum cleaner or a soft non-metallic bristle brush to remove the surface loaded fibers and dirt. Apply the tool in the direction of the fins.
- Spray the coil finned area and the return bends with a generous amount of the recommended coil cleaner (see below) using a pump-up sprayer or conventional spray bottle. Refer to the manufacturer's directions on the container for proper mixing ratio.
- After cleaning the coil use the approved chloride remover (see below) to remove soluble salts and revitalize the unit. Use a pump-up sprayer or a conventional spray bottle to soak the finned area and the return bends. Refer to the manufacturer's directions on the container.
- Rinse the coil finned area and the return bends with plenty of clean warm water. To avoid damaging the fins and the coating, it is important that the water temperature is below 130oF and the water pressure is below 100 PSI.
- Close and secure the evaporator door.

Recommended Coil Cleaner

Enviro-Coil Concentrate
Hydro-Balance Corporation
Tel. (972) 394-9422

Recommended Chloride Remover

CHLOR*RID DTS
CHLOR*RID International, Inc.
Tel. (800) 422-3217









Versatile, Dependable Walk-Ins & Blast Chillers



American panel is your trusted manufacturer for all your cold storage, blast chilling and shock freezing needs. Building on a 60-year family owned and operated heritage, American panel provides versatile, dependable custom crafted walk-in coolers, freezers, combination cold rooms and blast chillers.

American Panel is proud to offer the largest line of blast chillers and shock freezers on the market. 37 different freestanding models and an infinite number of integral configurations. HURRiCHiLL offers the easiest to use controls in the industry, blast chilling is complex but controlling it doesn't have to be. American Panel is the go-to source for all your blast chilling/shock freezing needs.

Find out more at www.americanpanel.com